

# Fast Recovery Epitaxial Diode (FRED) Module

**MEA 95-06 DA**  
**MEK 95-06 DA**  
**MEE 95-06 DA**

**V<sub>RRM</sub> = 600 V**  
**I<sub>FAV</sub> = 95 A**  
**t<sub>rr</sub> = 250 ns**

V <sub>RSM</sub> V	V <sub>RRM</sub> V	Type
600	600	<div style="display: flex; justify-content: space-around;"> <div style="text-align: center;"> <p><b>MEA95-06 DA</b></p> </div> <div style="text-align: center;"> <p><b>MEK 95-06 DA</b></p> </div> <div style="text-align: center;"> <p><b>MEE 95-06 DA</b></p> </div> </div>

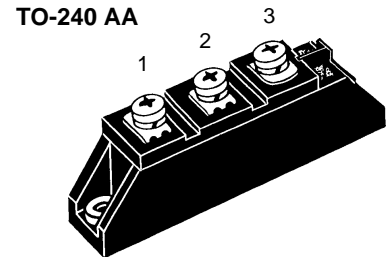

Symbol	Test Conditions	Maximum Ratings
I <sub>FRMS</sub>	T <sub>case</sub> = 75°C	142 A
I <sub>FAV</sub> ①	T <sub>case</sub> = 75°C; rectangular, d = 0.5	95 A
I <sub>FRM</sub>	t <sub>p</sub> < 10 μs; rep. rating, pulse width limited by T <sub>VJM</sub>	TBD A
I <sub>FSM</sub>	T <sub>VJ</sub> = 45°C; t = 10 ms (50 Hz), sine	1200 A
	t = 8.3 ms (60 Hz), sine	1300 A
	T <sub>VJ</sub> = 150°C; t = 10 ms (50 Hz), sine	1080 A
	t = 8.3 ms (60 Hz), sine	1170 A
I <sup>2</sup> t	T <sub>VJ</sub> = 45°C; t = 10 ms (50 Hz), sine	7200 A <sup>2</sup> s
	t = 8.3 ms (60 Hz), sine	7100 A <sup>2</sup> s
	T <sub>VJ</sub> = 150°C; t = 10 ms (50 Hz), sine	5800 A <sup>2</sup> s
	t = 8.3 ms (60 Hz), sine	5700 A <sup>2</sup> s
T <sub>VJ</sub>		-40...+150 °C
T <sub>stg</sub>		-40...+125 °C
T <sub>Hmax</sub>		110 °C
P <sub>tot</sub>	T <sub>case</sub> = 25°C	280 W
V <sub>ISOL</sub>	50/60 Hz, RMS t = 1 min	3000 V~
	I <sub>ISOL</sub> ≤ 1 mA t = 1 s	3600 V~
M <sub>d</sub>	Mounting torque (M5)	2.5-4/22-35 Nm/lb.in.
	Terminal connection torque (M5)	2.5-4/22-35 Nm/lb.in.
d <sub>s</sub>	Creep distance on surface	12.7 mm
d <sub>A</sub>	Strike distance through air	9.6 mm
a	Maximum allowable acceleration	50 m/s <sup>2</sup>
Weight		90 g

## Features

- International standard package with DCB ceramic base plate
- Planar passivated chips
- Short recovery time
- Low switching losses
- Soft recovery behaviour
- Isolation voltage 3600 V~
- UL registered E 72873

## Applications

- Antiparallel diode for high frequency switching devices
- Free wheeling diode in converters and motor control circuits
- Inductive heating and melting
- Uninterruptible power supplies (UPS)
- Ultrasonic cleaners and welders

## Advantages

- High reliability circuit operation
- Low voltage peaks for reduced protection circuits
- Low noise switching
- Low losses

## Dimensions in mm (1 mm = 0.0394")

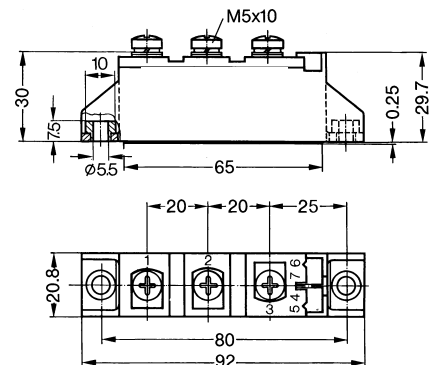

Symbol	Test Conditions	Characteristic Values (per diode)		
		typ.	max.	
I <sub>R</sub>	T <sub>VJ</sub> = 25°C V <sub>R</sub> = V <sub>RRM</sub>		2 mA	
	T <sub>VJ</sub> = 25°C V <sub>R</sub> = 0.8 • V <sub>RRM</sub>		0.5 mA	
	T <sub>VJ</sub> = 125°C V <sub>R</sub> = 0.8 • V <sub>RRM</sub>		34 mA	
V <sub>F</sub>	I <sub>F</sub> = 100 A; T <sub>VJ</sub> = 125°C		1.36 V	
	T <sub>VJ</sub> = 25°C		1.55 V	
	I <sub>F</sub> = 300 A; T <sub>VJ</sub> = 125°C		2.05 V	
	T <sub>VJ</sub> = 25°C		2.09 V	
V <sub>T0</sub>	For power-loss calculations only		1.01 V	
r <sub>T</sub>	T <sub>VJ</sub> = 125°C		2.85 mΩ	
R <sub>thJH</sub>	DC current		0.550 K/W	
R <sub>thJC</sub>	DC current		0.450 K/W	
t <sub>rr</sub>	I <sub>F</sub> = 100 A V <sub>R</sub> = 300 V -di/dt = 200 A/μs	250	T <sub>VJ</sub> = 100°C	300 ns
I <sub>RM</sub>			T <sub>VJ</sub> = 25°C	14 A
			T <sub>VJ</sub> = 100°C	21 A

① I<sub>FAV</sub> rating includes reverse blocking losses at T<sub>VJM</sub>, V<sub>R</sub> = 0.6 V<sub>RRM</sub>, duty cycle d = 0.5  
Data according to IEC 60747

IXYS reserves the right to change limits, test conditions and dimensions

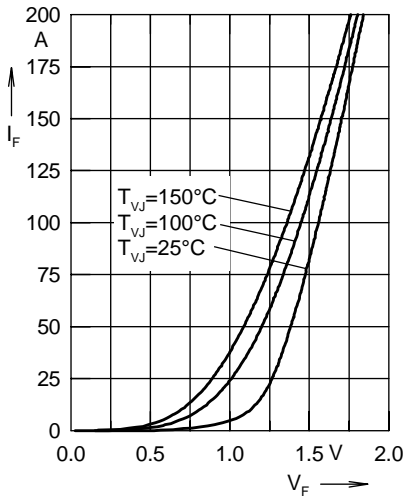

Fig. 1 Forward current  $I_F$  versus voltage drop  $V_F$  per leg

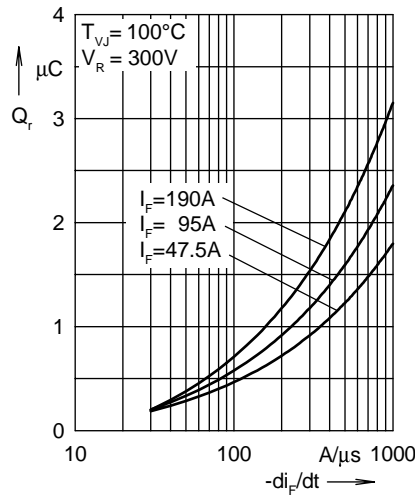

Fig. 2 Reverse recovery charge  $Q_r$  versus  $-di_F/dt$

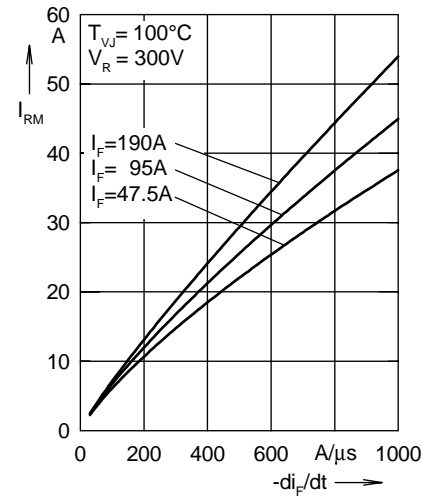

Fig. 3 Peak reverse current  $I_{RM}$  versus  $-di_F/dt$

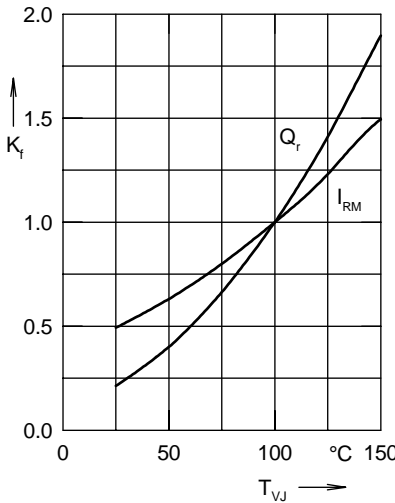

Fig. 4 Dynamic parameters  $Q_r$ ,  $I_{RM}$  versus junction temperature  $T_{VJ}$

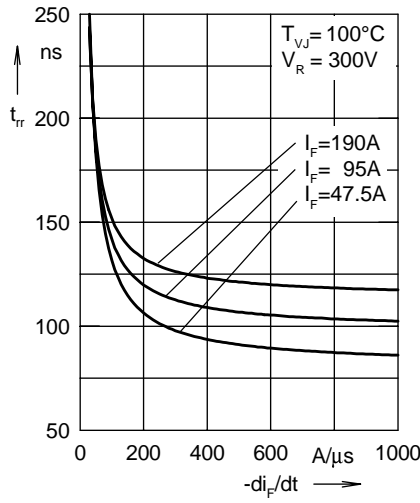

Fig. 5 Recovery time  $t_{rr}$  versus  $-di_F/dt$

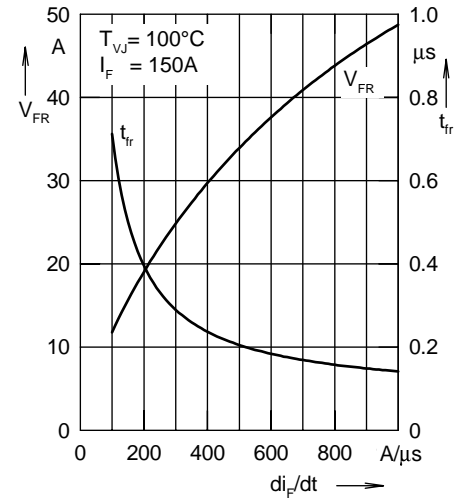

Fig. 6 Peak forward voltage  $V_{FR}$  and  $t_{fr}$  versus  $di_F/dt$

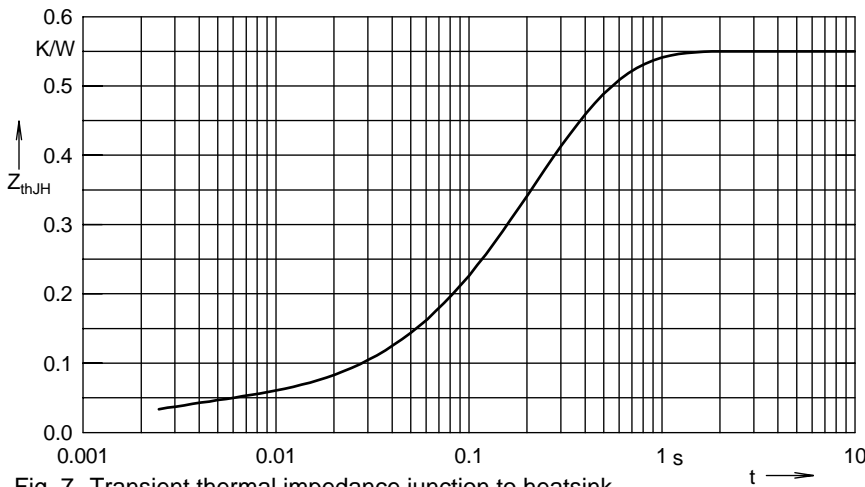

Fig. 7 Transient thermal impedance junction to heatsink

Constants for  $Z_{thJH}$  calculation:

i	$R_{thi}$ (K/W)	$t_i$ (s)
1	0.037	0.002
2	0.138	0.134
3	0.093	0.25
4	0.282	0.274